

DIN W48×H24mm, Indication only, LCD pulse meter(RPM, RPS, Hz)

■ Features

- Upgraded version of LR7N series
- Easy of 1 pulse input method per 1 revolution
- Display up to 10000RPM
- No need power supply by internal battery
- Protection structure IP66(Front panel only)
- Displays RPM, RPS of rotor
- Displays AC line frequency



⚠ Please read "Caution for your safety" in operation manual before using.

■ Ordering information

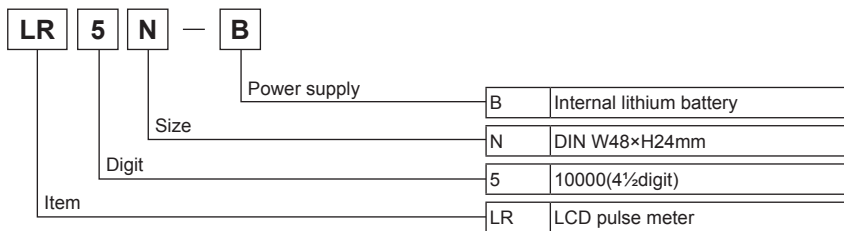

■ Specifications

Model	LR5N-B		
Input method	No-voltage input	Voltage input 1	Voltage input 2
Input signal level	Short-residual voltage : Max. 0.5V Max. short-circuit impedance : Max. 10kΩ Max. open-circuit impedance : Min. 500kΩ	DC	High input voltage range : 4.5-30VDC Low input voltage range : 0-2VDC
		AC	Voltage:3-30VAC
Power	No-power [includes lithium battery(replaceable)]		
Battery life cycle	Over 3 years at 20°C(replaceable)		
Display method	LCD Zero blanking method(character height:8.7mm)		
Display digits	5 digit		
Display range and Display accuracy	Display range		Display accuracy
	RPM	1 to 10000RPM	1 to 5000RPM: F.S.±0.05%±1digit 5001 to 10000RPM: F.S.±0.1%±1digit
	0.1RPM	0.1 to 1000.0RPM	F.S.±0.05%±1digit
	Hz	1 to 1000Hz	F.S.±0.1%±1digit
	0.1Hz	0.1 to 100.0Hz	
RPS	1 to 1000RPS		
HOLD function	Includes(external HOLD function)		
Insulation resistance	100MΩ (at 500VDC megger)		
Dielectric strength	2,000VAC 50/60Hz for 1 min. (cutoff current=10mA)		
Vibration	Mechanical	0.75mm amplitude at frequency of 10 to 55Hz(for 1min.) in each X, Y, Z direction for 1 hours	
	Malfunction	0.3mm amplitude at frequency of 10 to 55Hz(for 1min.) in each X, Y, Z direction for 10 min.	
Shock	Mechanical	300m/s²(approx. 30G) in X, Y, Z directions for 3 times	
	Malfunction	100m/s²(approx. 10G) in X, Y, Z directions for 3 times	
Environment	Ambient temperature	-10 to 55°C, Storage: -25 to 65°C	
	Ambient humidity	35 to 85%RH, Storage: 35 to 85%RH	
Protection	IP66(when using waterproof rubber for front panel), Terminal cover(finger protector)		
Weight*1	Approx. 91.5g (approx. 59g)		

*1: The weight is with packaging and the weight in parentheses is only unit weight.
 ※Environment resistance is rated at no freezing or condensation.

- (A) Photo electric sensor
- (B) Fiber optic sensor
- (C) Door/Area sensor
- (D) Proximity sensor
- (E) Pressure sensor
- (F) Rotary encoder
- (G) Connector/Socket
- (H) Temp. controller
- (I) SSR/ Power controller
- (J) Counter
- (K) Timer
- (L) Panel meter
- (M) Tacho/ Speed/ Pulse meter
- (N) Display unit
- (O) Sensor controller
- (P) Switching mode power supply
- (Q) Stepper motor& Driver&Controller
- (R) Graphic/ Logic panel
- (S) Field network device
- (T) Software
- (U) Other

■ Connections

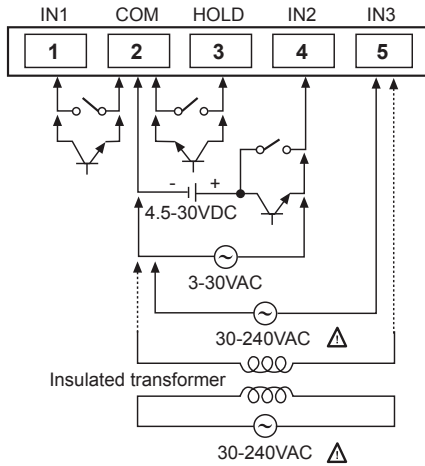

※Please use reliable contacts enough to flow 5μA of current when using input signal or reset signal as a contact.

※IN1 - No-voltage input

IN2 - Voltage input

• DC voltage input

• AC voltage input : Display AC frequency.

IN3 - AC voltage input : Display AC frequency.

※Choose one among IN1, IN2 and IN3 to use.

⚠Caution for IN3 input

: If apply high voltage over 50VAC, it may cause an electric shock. Insulated transformer whose turn ratio is 1:1 must be installed, or countermeasures must be provided.

■ Operation charts

● Setting RPS, Hz

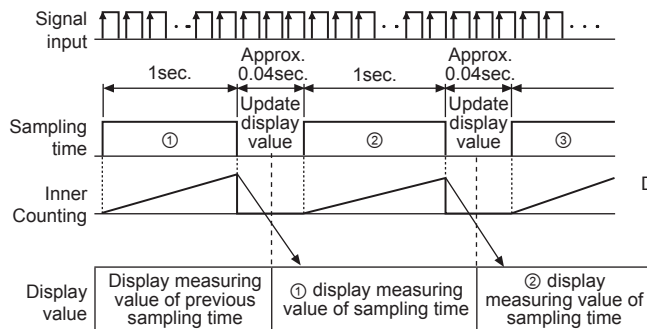

● Setting RPM 0.1, RPM 0.1Hz

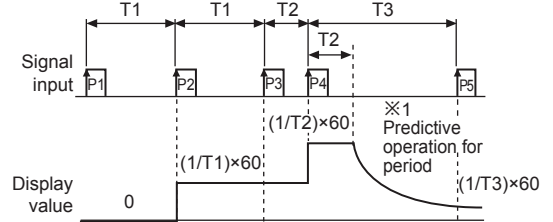

※1: It implements Predictive operation for period without Auto zero time setting function (If there is no pulse input within setting time, it displays the value as zero forcibly). If there is any input signal within certain time (T2), CPU considers input to be supplied, display value is decreased continuously.

■ Operation mode (frequency/revolution)

○ Frequency (Hz, 0.1Hz) = f, Revolution (RPM, 0.1RPM) = f × 60, Revolution (RPS) = f

● Revolution

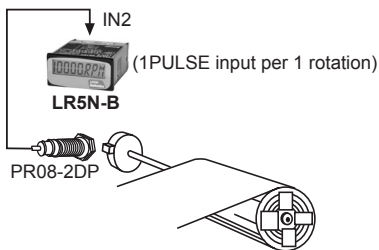

● AC frequency

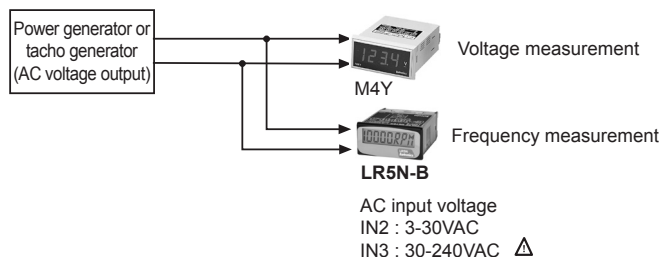

● Display value and unit

Display	Frequency		Revolution		
Unit	Hz	0.1Hz	RPM	0.1RPM	RPS(factory default)

Compact LCD Pulse Meter

■ Dimensions

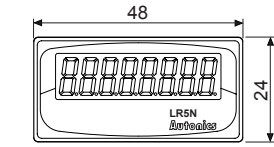

● Panel cut-out

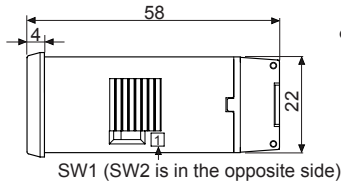
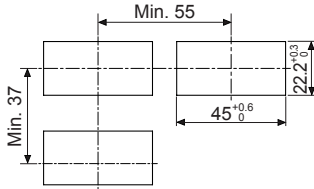

SW1 (SW2 is in the opposite side)

● Bracket

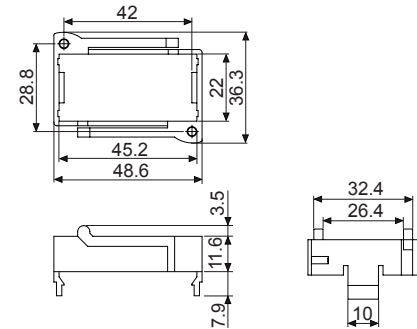

(unit: mm)

■ Input connections

● Standard input sensor

: NPN open collector output type

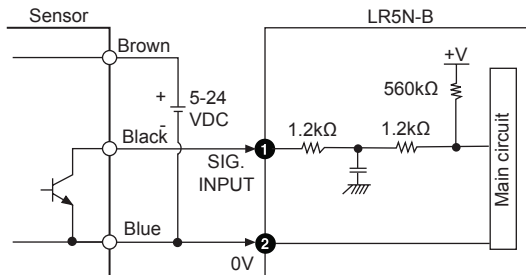

■ Function description

● RESET

It initializes a unit and front LCD display. There are not indicated when set switch1 as RESET.

● HOLD

It stops display value by short circuit HOLD terminal when it is hard to read the value because of frequent input changes.

■ Display range selection

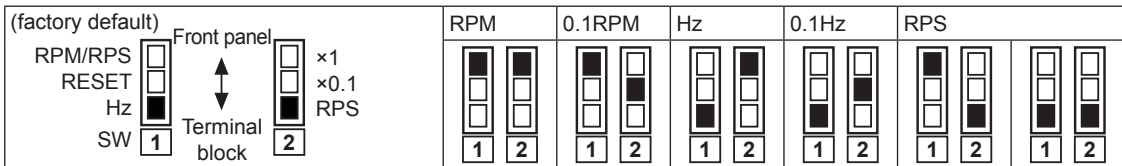

① Select one among ×1, ×0.1 and RPS by SW2.

② Shift SW1 to RESET.

③ Select one again between RPM/RPS and Hz by SW1.

※If set display range and front display LCD unit are not same, shift SW1 to RESET and select RPM/RPS or Hz.

■ Case detachment and Battery replacement

● Case detachment

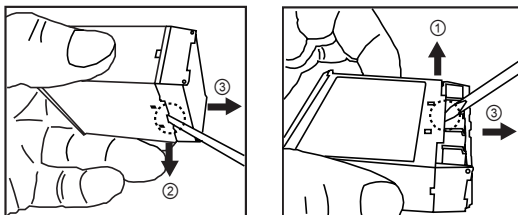

※Hold up Lock part toward ①, ② of the product with the tool and pull toward ③, the case is detached.

⚠ Please be careful of the injury caused by tools.

● Battery replacement

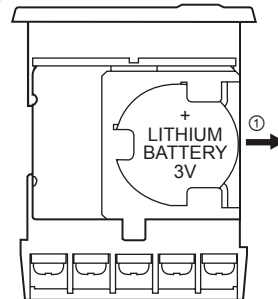

1) Detach the case.

2) Push the battery and detach toward ①.

3) Insert new battery with correct alignment of polarity pushing toward opposite of ①.

※Battery is sold separately.

※Do not burn up or disassemble the lithium battery.

(A)	Photo electric sensor
(B)	Fiber optic sensor
(C)	Door/Area sensor
(D)	Proximity sensor
(E)	Pressure sensor
(F)	Rotary encoder
(G)	Connector/Socket
(H)	Temp. controller
(I)	SSR/ Power controller
(J)	Counter
(K)	Timer
(L)	Panel meter
(M)	Tacho/ Speed/ Pulse meter
(N)	Display unit
(O)	Sensor controller
(P)	Switching mode power supply
(Q)	Stepper motor& Driver&Controller
(R)	Graphic/ Logic panel
(S)	Field network device
(T)	Software
(U)	Other